

XP1

+U	1
+U	2
+U	3
+U	4
-U	5
-U	6
-U	7
-U	8
RxD	9
RxD	10
TxD	11
TxD	12
W/R	13
W/R	14
+5V	15
+5V	16
GND	17
GND	18
SHIELD	19
SHIELD	20

XP2

1A	A
2A	B
3A	Z
4A	Y
5A	Shield

XP3

16	A
26	B
36	Z
46	Y
56	Shield

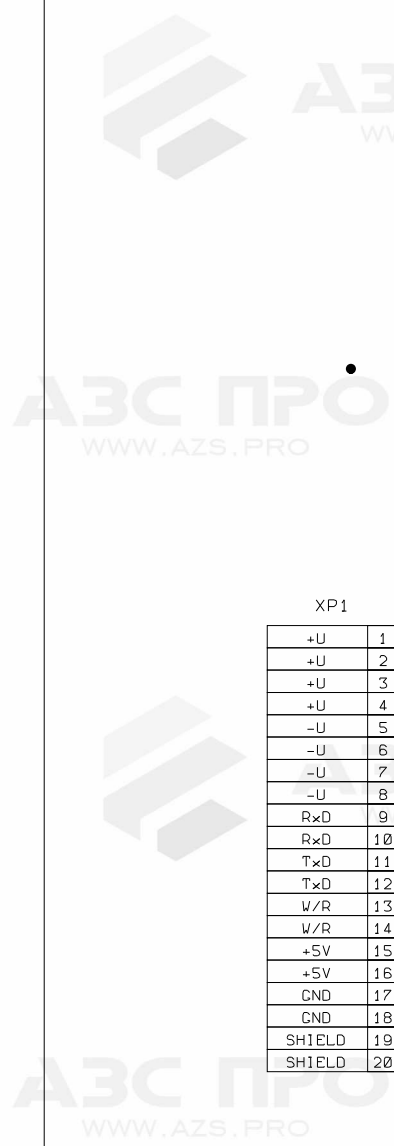

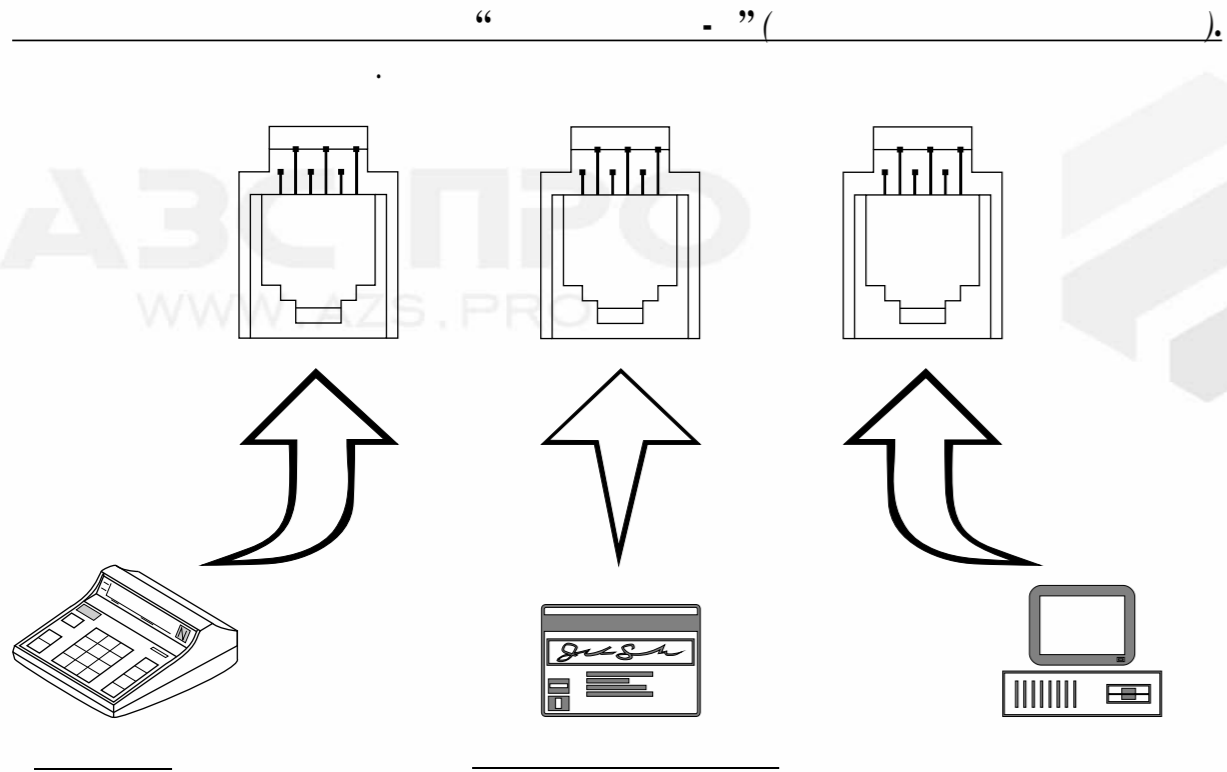
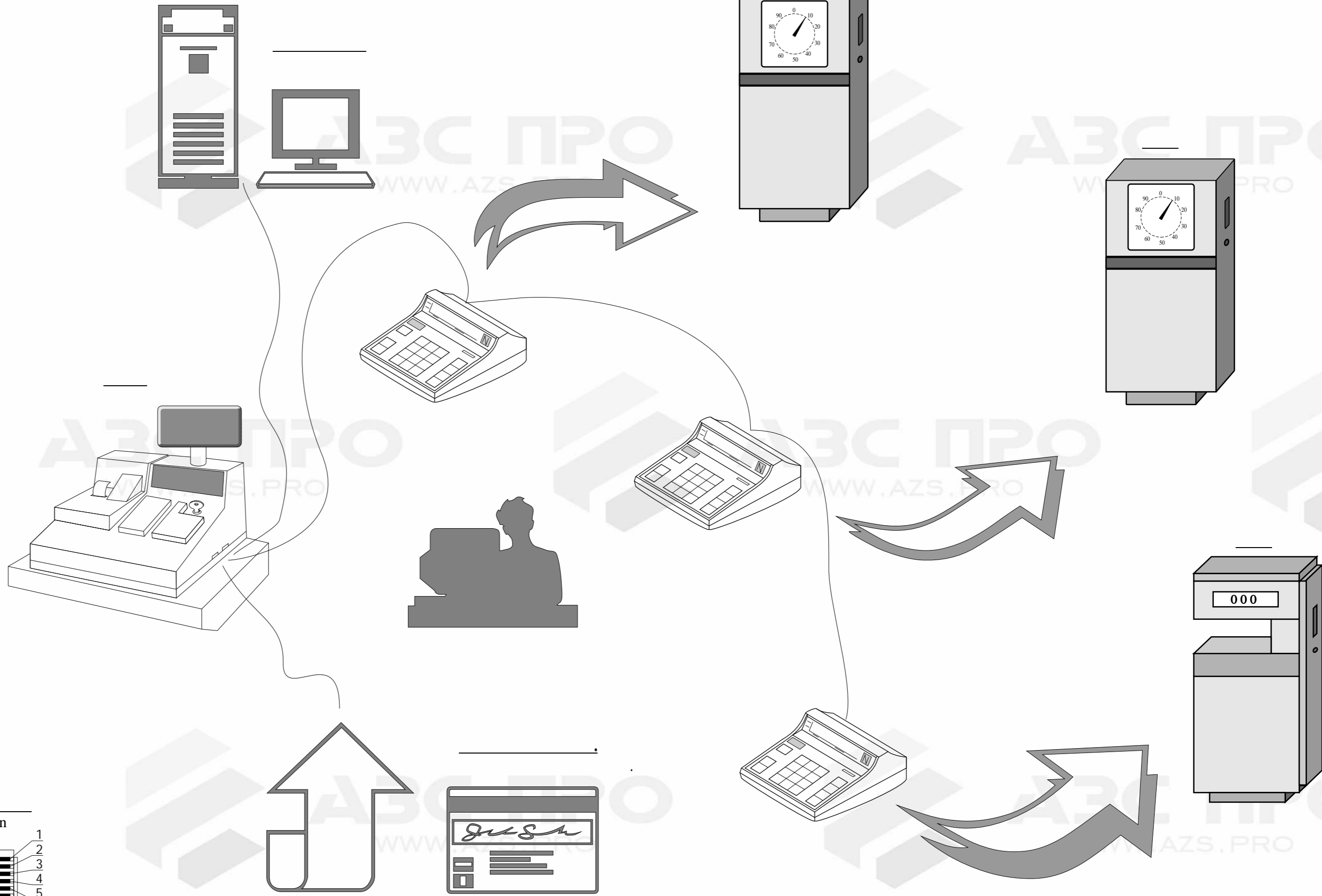
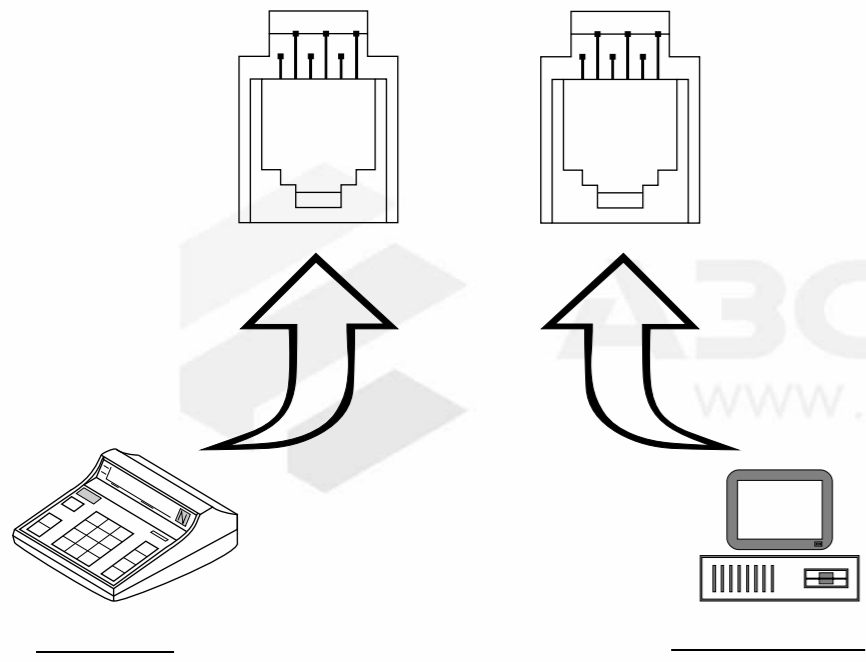

Hold	1	←	→	1	Hold
GND	2	←	→	2	GND
TxD	3	←	→	3	TxD
RxD	4	←	→	4	RxD
+U	5	←	→	5	+U
NC	6	←	→	6	NC

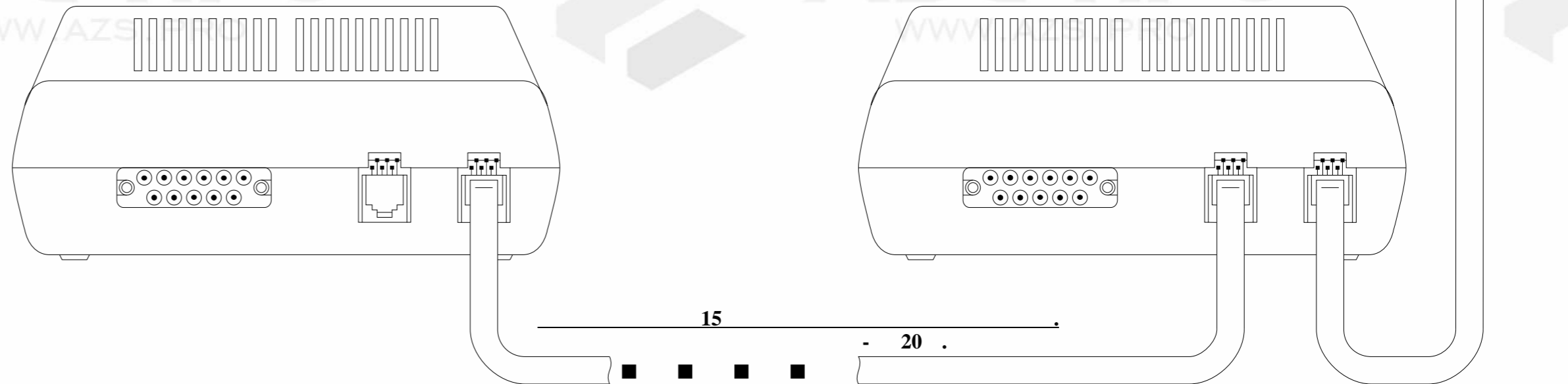
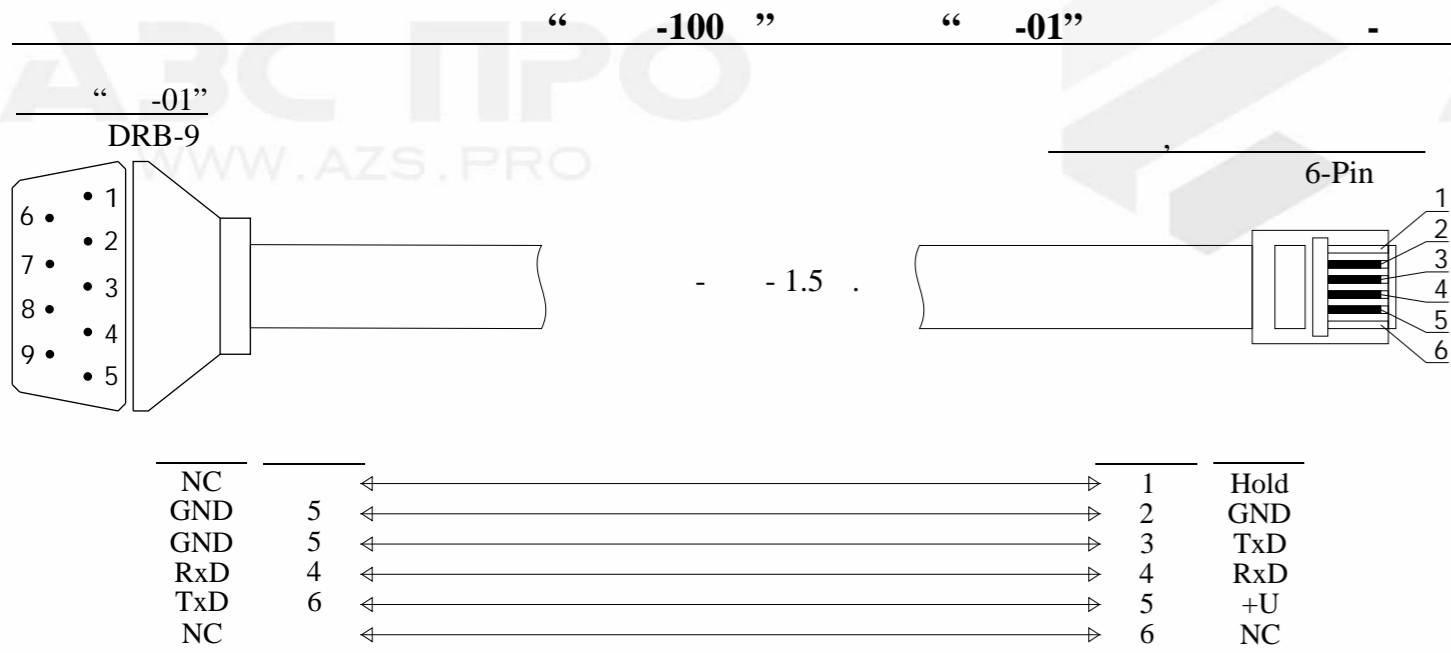



AZS PRO
WWW.AZS.PRO



AZS PRO
WWW.AZS.PRO



AZS PRO
WWW.AZS.PRO

AZS PRO
WWW.AZS.PRO



AZS PRO
WWW.AZS

AZS PRO
WWW.AZS

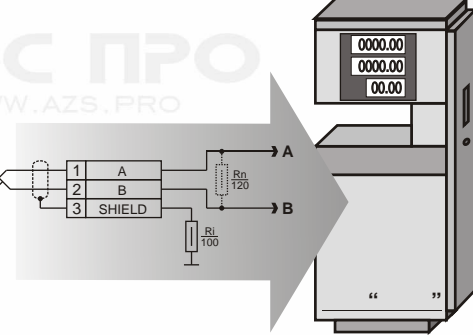
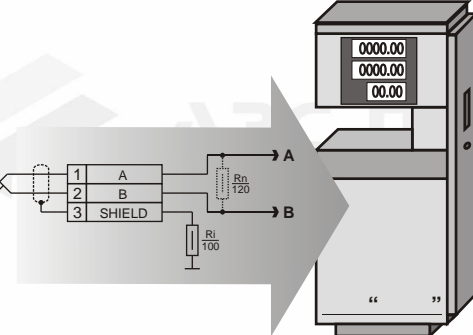
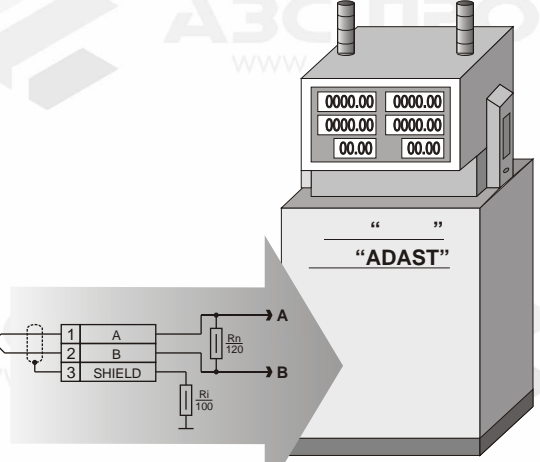
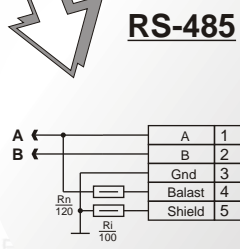
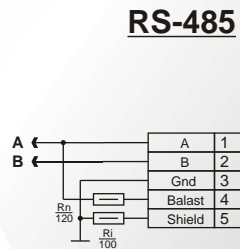
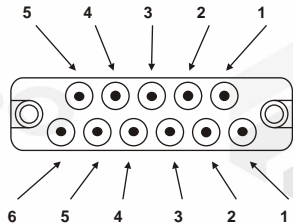
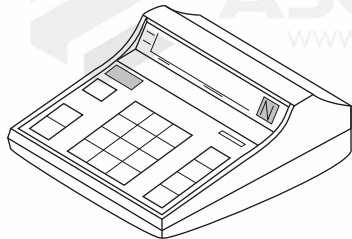

-01(485)	E1	E2	E3	E4	E5
RS-485	1-2	1-2	1-2		

WWW.AZS.PRO

AZS PRO
WWW.AZS.P

AZS PRO
WWW.AZS.PRO

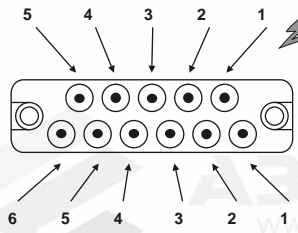
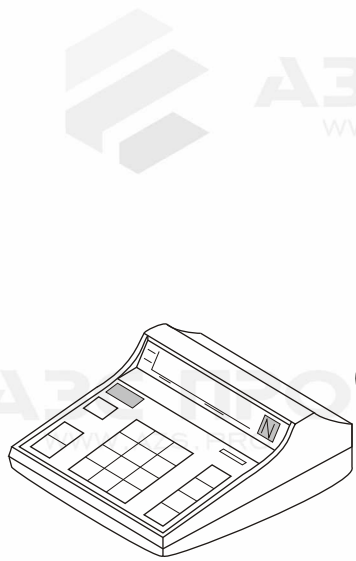

IRPS

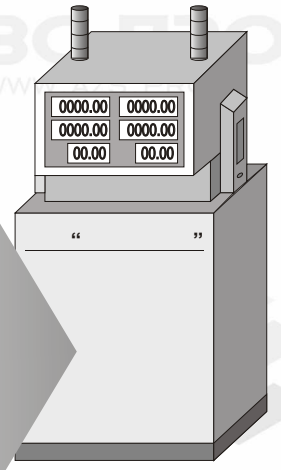
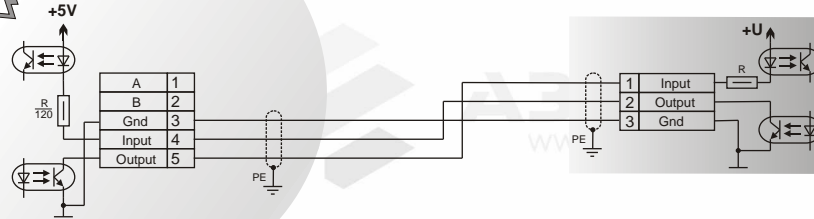

-01(485)	E1	E2	E3	E4	E5
IRPS	2-3	2-3	3-4		X

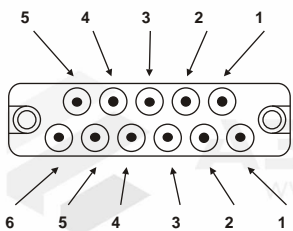

RS-422

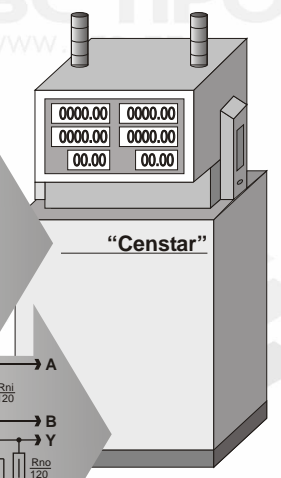
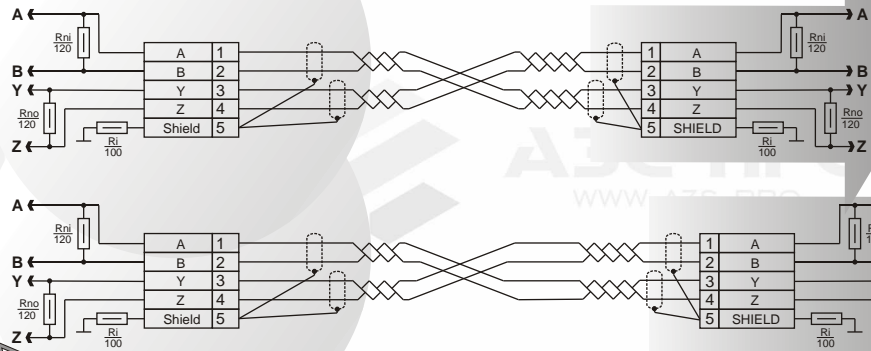

-02(422)	E1	E2	E3	E4	E5	E6	E7
RS-422						1-2	1-2